







- N1  1x
- N2  6x
- N3  4x
- N4  1x
- N5  1x
- N6  4x



I

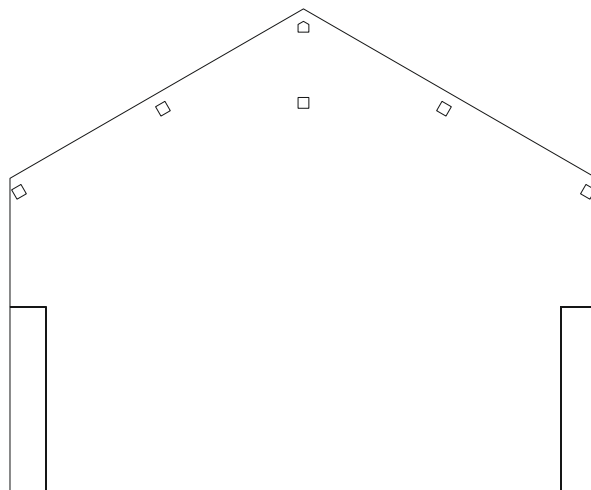
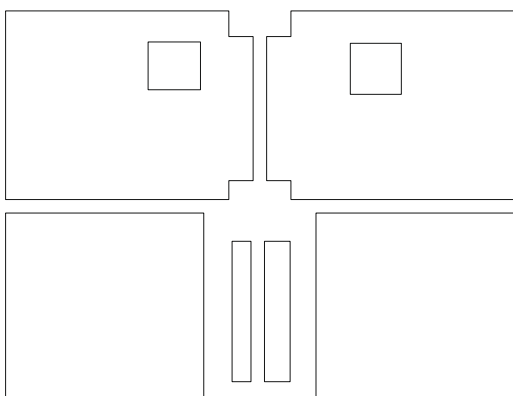
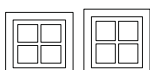
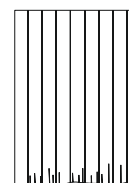
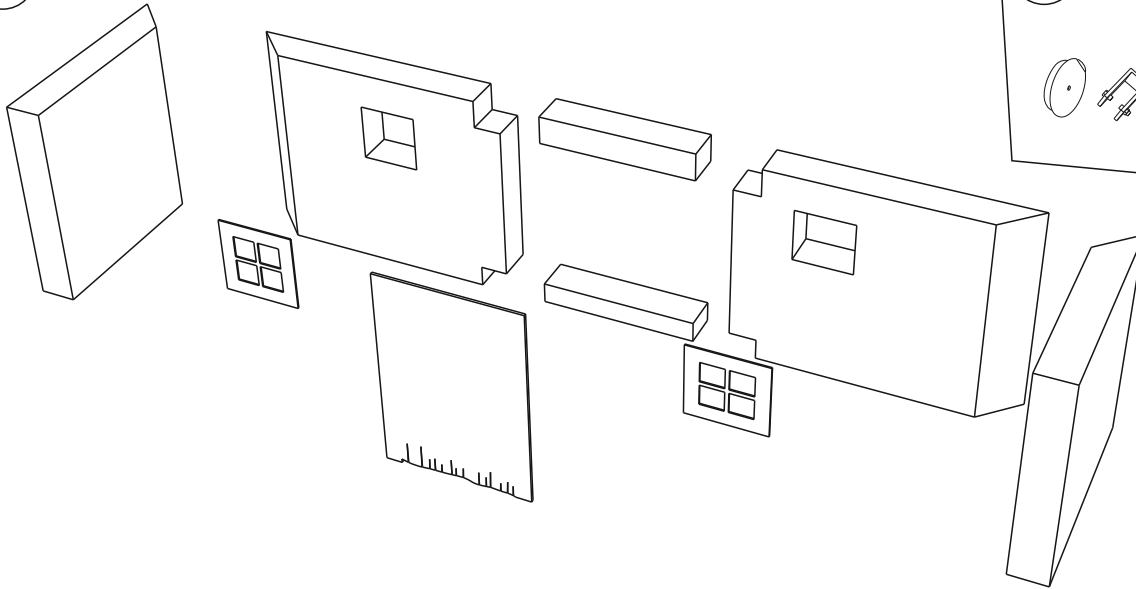

II

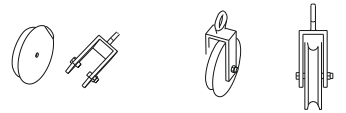

III

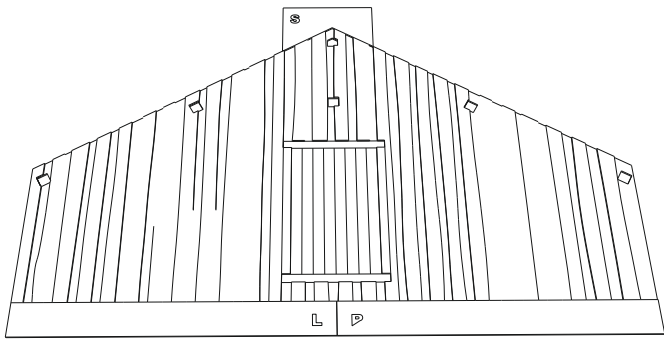

IV

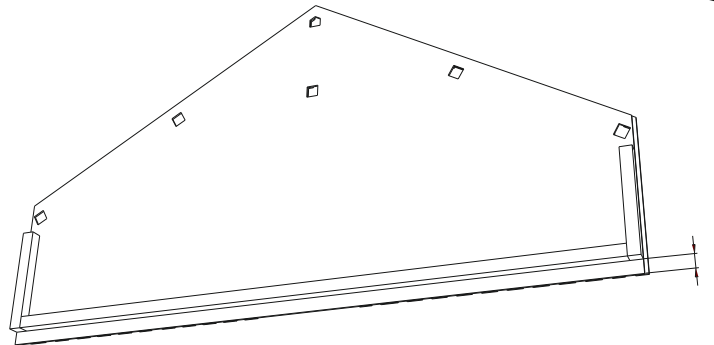

V

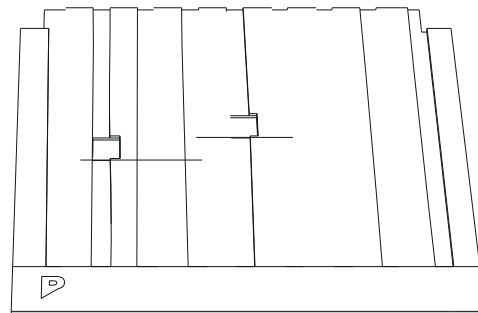
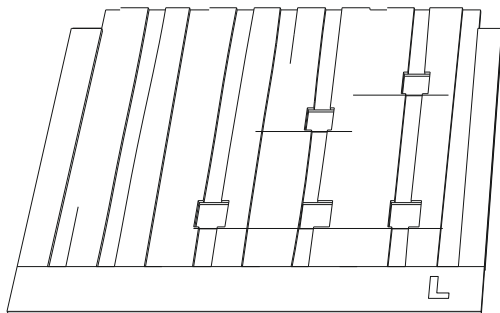

VI

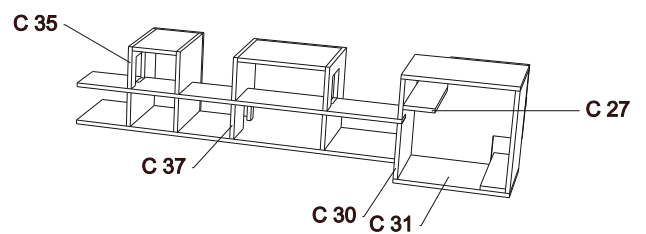
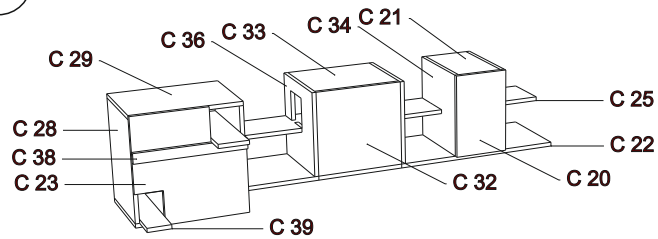

VII

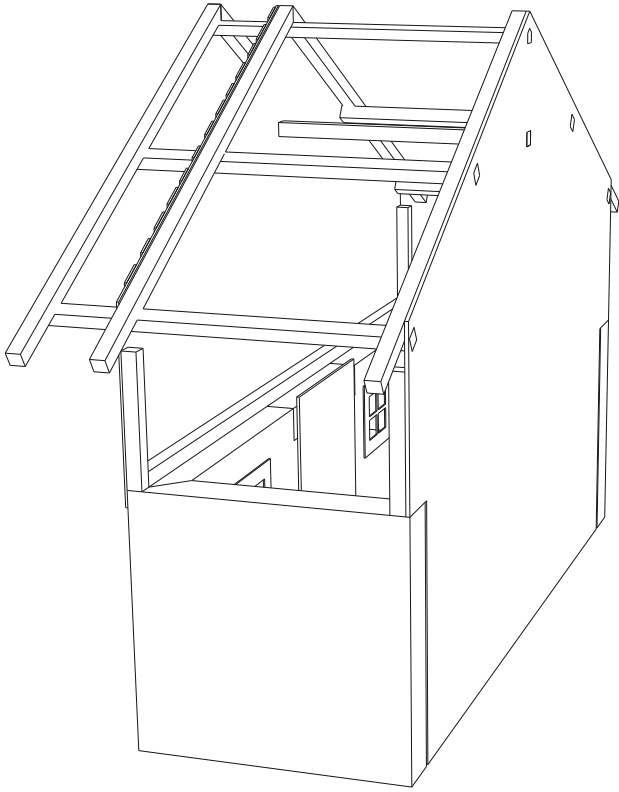

VIII

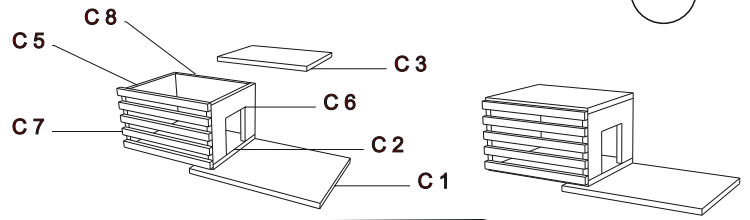

IX

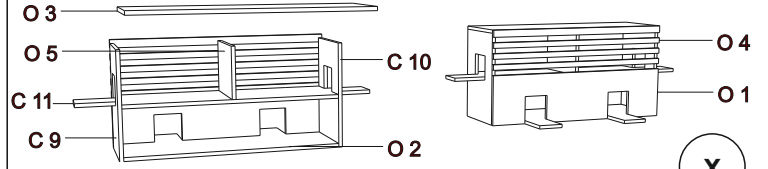
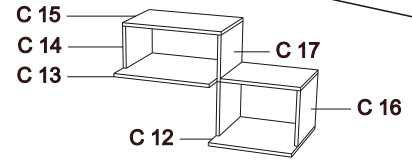

X

XI

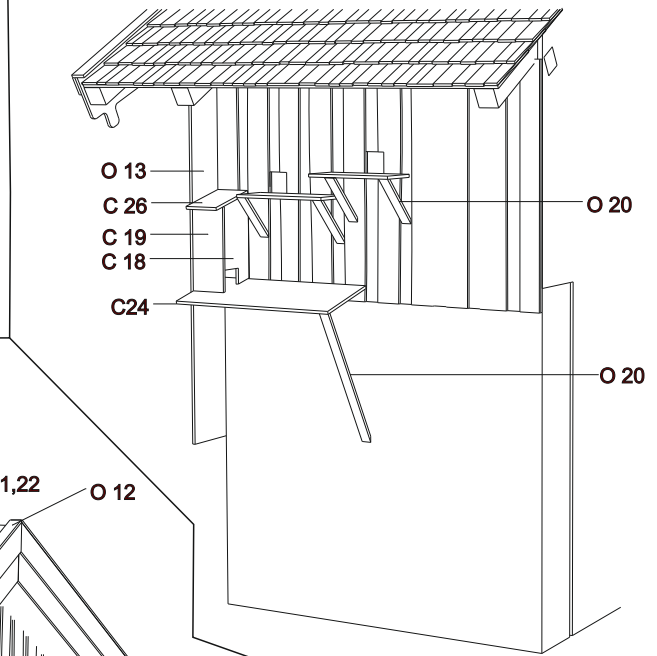

XII

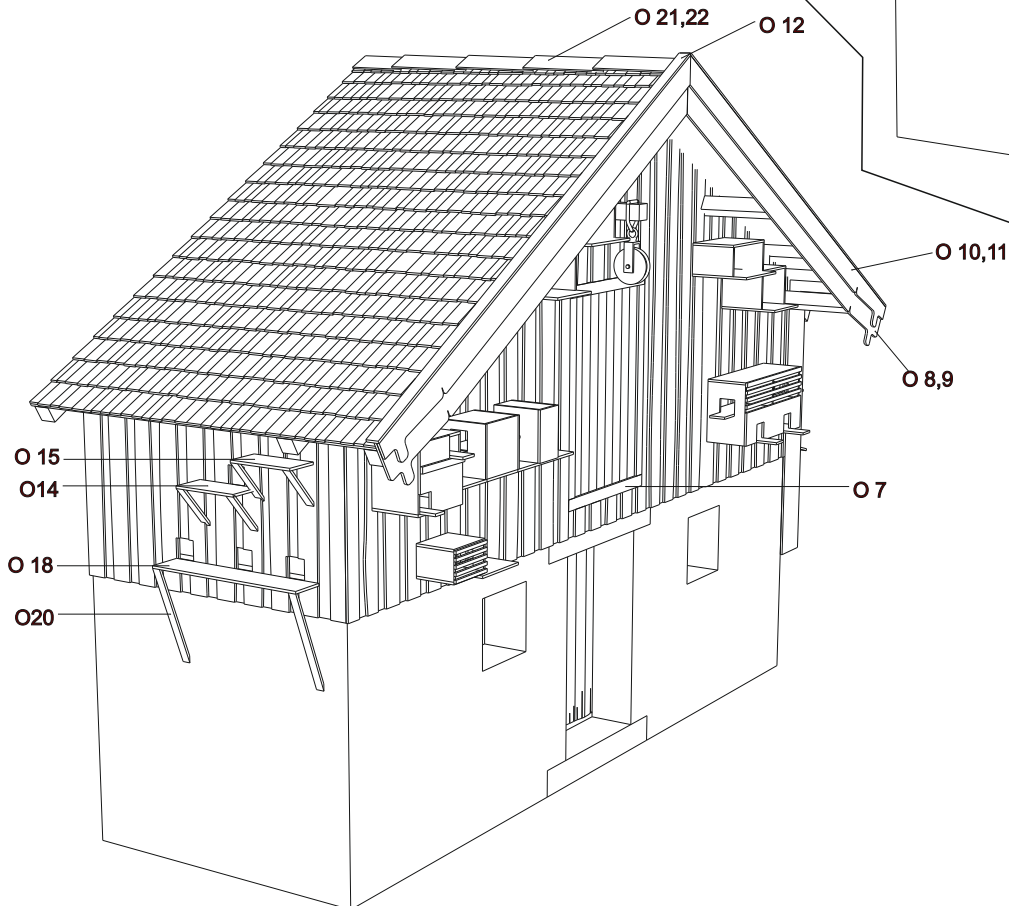

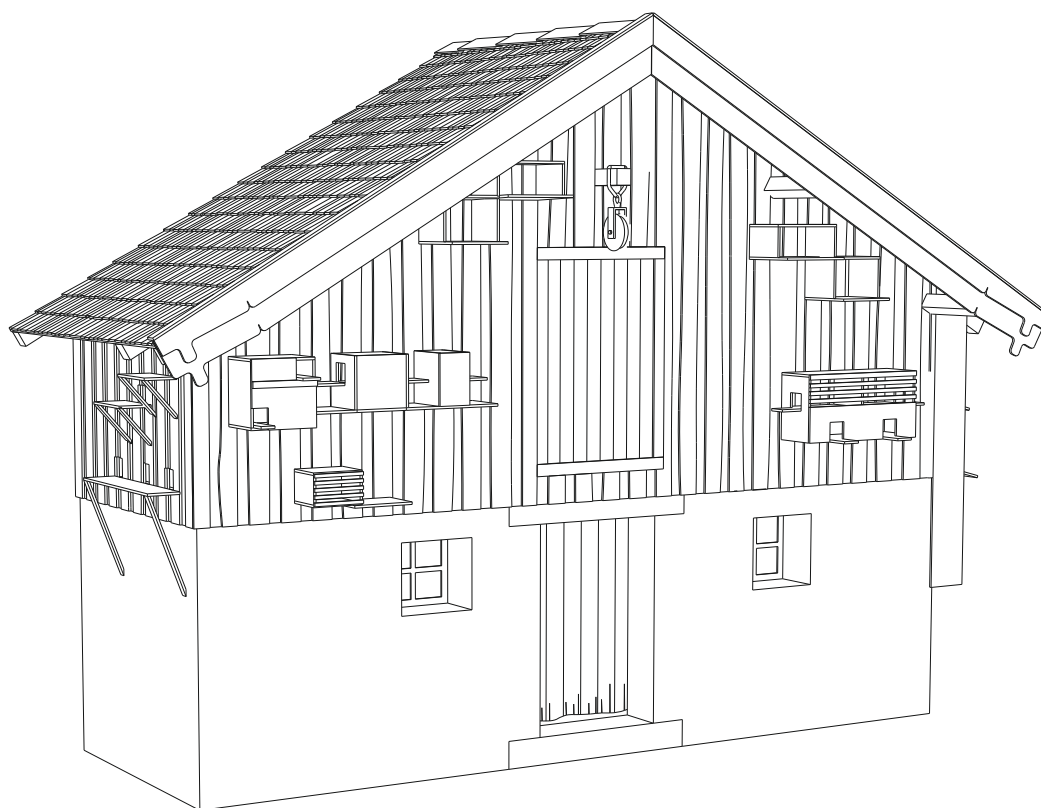
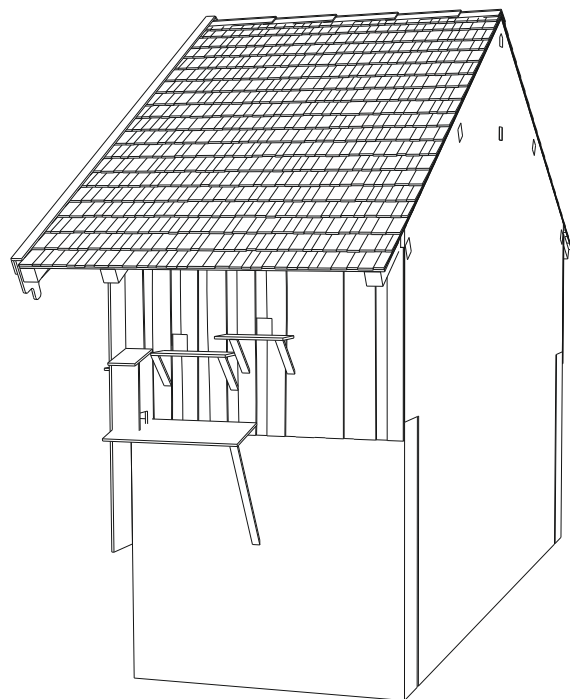
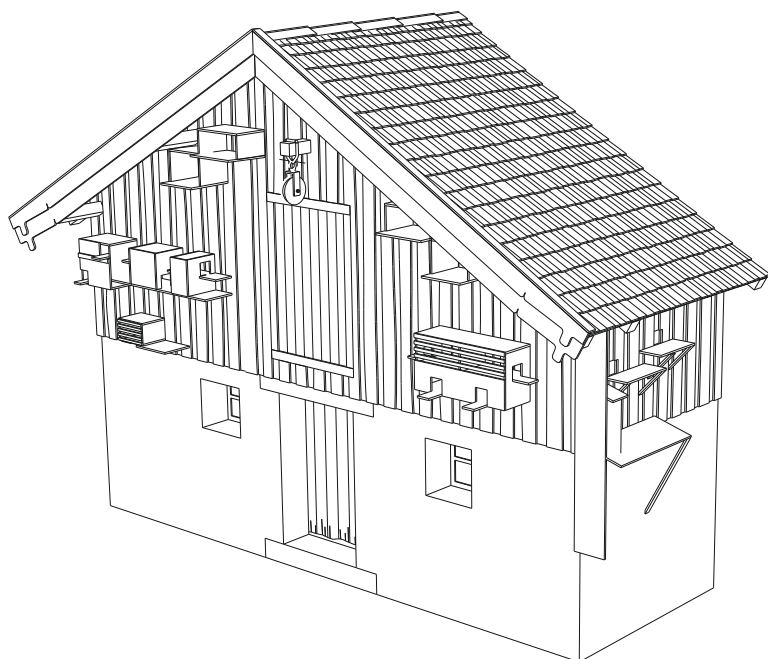

Návod ke stavbě

Při stavbě postupujte podle instruktážních obrázků.

Upozornění: Během opracování může vznikat prach, který může dráždit dýchací cesty. Používejte ochranu očí při odstřihování kovových dílů.

Instructions

Follow the instruction drawings the assembly

Notice: Machining can produce dust which can be irritating to the respiratory tract. Metal parts should be cut off using protection eyesight.

Plus Model s.r.o
Jižní 56, 370 10 České Budějovice
Czech Republic
<http://www.plusmodel.cz>
e-mail: plusmodel@plusmodel.cz

plusmodel

Kupujte přímo na www.plusmodel.cz
Buy directly from www.plusmodel.cz